

# Cargo 1300

**80x120 INSIDE**



**ATP**













## Isothermal container for the transport of chilled and frozen products at a controlled temperature

- Suitable for supermarket chains, logistics operators, chilled or frozen food distributors and manufacturers, carriers.
- Europallet **internal dimensions**: maximum convenience in loading and unloading of goods on pallets.
- 1350 litres of capacity.
- Total compliance with the cold chain at all stages of transport.
- Speeds up distribution operations at the point of sales: it can be loaded inside the cold room of the wholesale centre and unloaded at the refrigerated counter of the destination supermarket.
- It can be transported using conventional vehicles: it allows to simultaneously transport chilled, frozen and ambient temperature products using a single non-insulated vehicle.
- Manufactured using the rotational moulding technology: mono-block container and door (free of sharp edges, joints and welds).
- Fully recyclable at the end of the operating life.

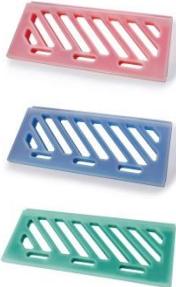

### MANUFACTURING MATERIALS

<b>Polyethylene</b>	inner and outer walls of the container and the door; suitable for food contact	<b>Polyurethane</b>	insulating material between the walls of the container and the door; free of CFC and HCFC
<b>Silicone</b>	seal	<b>Nylon</b>	wheels
<b>Polypropylene</b>	hinges	<b>Stainless steel</b>	handling handles, closing handle, inner rod of the door
<b>Galvanised steel</b>	hinge rods, connecting rods hinged plates, runner support		

**TECHNICAL CHARACTERISTICS**

	<p>Equipped with 6 feet of galvanized steel h 120 mm.</p>		<p>4 runners 125 mm diameter (2 fixed and 2 swivel of which one equipped with brake). Support runners plate integrated in the container.</p>
	<p>Europallet drip tray (on request)</p>		<p>Label holder (on request) for the identification of the content or destination. Suitable for A5 format documents.</p>
	<p>Door opens up to 270° with door retaining catch.</p>		<p>Easily removable door seal.</p>
	<p>Dual pivot hinge system. Better stability of the door over time.</p>		<p>Chilled and frozen and extra frozen eutectic plates, to increase temperature retention performance over time (on request).</p>
	<p>Stainless steel locking handle with release button.</p>		<p>Handle prepared for the use of tamper-proof system.</p>
	<p>Internal temperature can be checked through a thermometer installed in the door (on request).</p>		<p>Available (on request) USB data logger to record temperature data during transport</p>

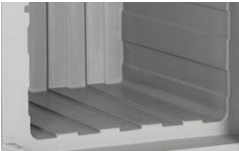
## TECHNICAL CHARACTERISTICS

	<p>Internal grooves improving good air circulation.</p>		<p>Mono-block structure, no sharp edges, joints and welds.</p>
	<p>Insulated with CFC and HCFC-free polyurethane foam.</p>	<p>°C</p>	<p>Guaranteed for use: <b>from -30° to +100° C.</b></p>
<p><b>K</b></p>	<p>Coefficiente globale di trasmissione termica: <b>K=0,35 W/m²K</b></p>		

## TECHNICAL SPECIFICATIONS

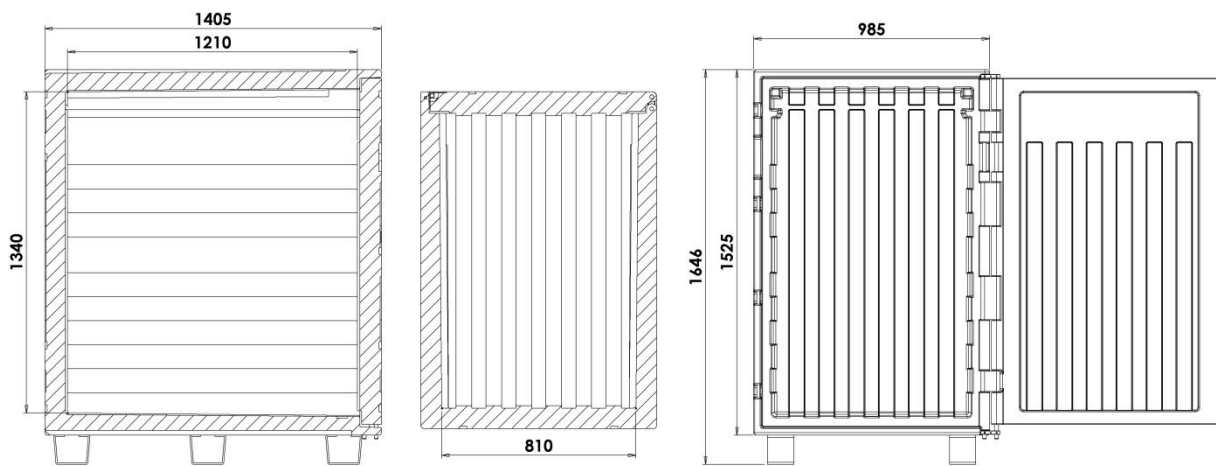

**with feet**

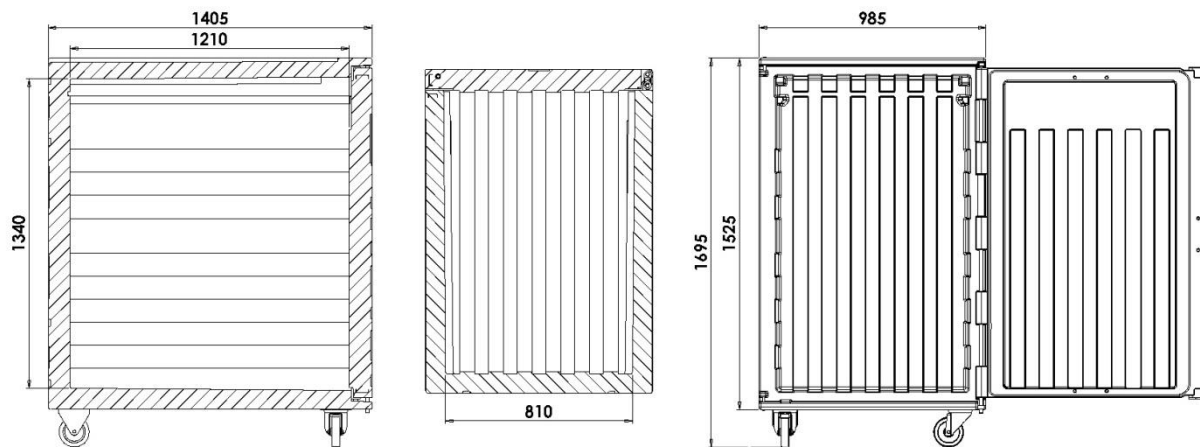

**with runners**

Model	Code	Colour	External dim. (mm)	Internal dim. (mm)	Capacity (liters)	Weight (Kg)
Cargo 1300 with castors diam.125	13019009	melange grey blue	985x1405xh1695	810x1210xh1340	1350	153
Cargo 1300 with feet	13010003	melange grey blue	985x1405xh1646	810x1210xh1340	1350	153
Cargo 1300 with pallet	13010005	melange grey blue	985x1405xh1646	810x1210xh1340	1350	153
Label holder	AMC101	transparent	173xh200	148xh210 -A5-		
Pallet drip tray	ANA00101	blu	800X1200			
Eutectic plate Chilled +3°C - 3 x Cargo -	PE110001	rosa	835x353xh45			7,6
Eutectic plate Frozen - 21°C - 3 x Cargo -	PE110002	blu	835x353xh45			7,6
Eutectic plate Extra Frozen - 21°C - 3 x Cargo -	PE119008	verde	835x353xh45			7,6
Data logger USB	AFG007		80x33xh14			

