

CARGO 500 CATERING



ATP

















Insulated container for meals transport at controlled temperature

- Properly conceived for catering and banqueting operations.
- The practical **adaptors** inside the container allow the insertion of **GN pans** of different heights and **GN trays**.
- 500 litres capacity.
- Total compliance with the cold chain at all stages of transport.
- It can be transported using conventional vehicles: it allows to simultaneously transport hot, chilled, frozen and ambient temperature products using a single non-insulated vehicle.
- Manufactured using the rotational moulding technology: mono-block container and door (free of sharp edges, joints and welds).
- Fully recyclable at the end of the operating life.

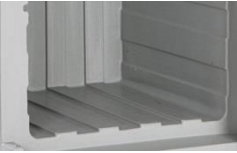
MANUFACTURING MATERIALS

Polyethylene	inner and outer walls of the container and the door; suitable for food contact	Polyurethane	insulating material between the walls of the container and the door; free of CFC and HCFC
Silicone	seal	Nylon	runners
Galvanised steel	support runners	Stainless steel	handling handles, closing handle, inner rod of the door, hinge rod, GN adaptors

TECHNICAL CHARACTERISTICS

	<p>4 castors of 100 mm diameter (2 fixed and 2 swivel of which one equipped with a brake). Support runners plate integrated in the container.</p>		<p>Label holder (on request) for the identification of the content or destination. Suitable for A5 format documents.</p>
	<p>Stainless steel locking handle with release button.</p>		<p>Handle prepared for the use of tamper-proof system.</p>
	<p>Eutectic plates, to increase temperature retention performance over time (on request).</p>		<p>Available (on request) towing set to move more than one container at the same time.</p>
	<p>Analog thermometer installed in the door (on request).</p>		<p>Polycarbonate GN pans of different heights. Melform exclusive design.</p>
	<p>Internal grooves improving good air circulation.</p>		<p>Door opens up to 270° with door retaining catch.</p>
	<p>Easily removable door seal.</p>		<p>Stainless steel rod with 2 hooks integrated inside the door.</p>
	<p>Mono-block structure, no sharp edges, joints and welds.</p>		<p>Insulated with CFC and HCFC-free polyurethane foam.</p>
<p style="font-size: 2em; font-weight: bold; text-align: center;">K</p>	<p>Overall heat transmission coefficient: K = 0.35 W/m²K</p>	<p style="font-size: 2em; font-weight: bold; text-align: center;">°C</p>	<p>Guaranteed for use: from -30° to +100° C.</p>

TECHNICAL SPECIFICATIONS

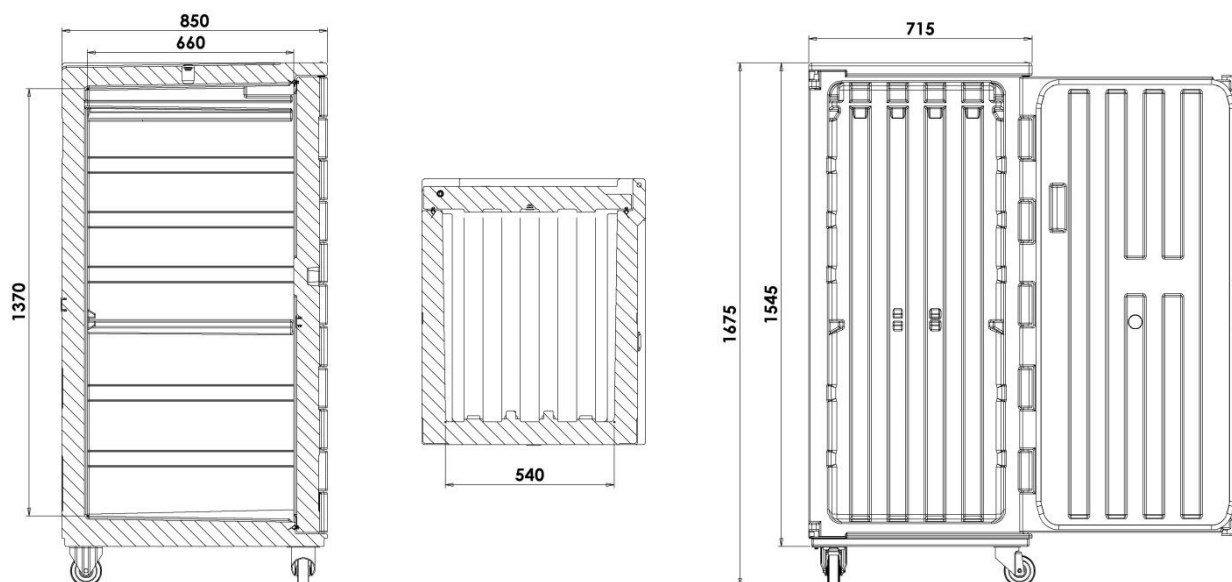

ADAPTORS FOR GN PANS

H65

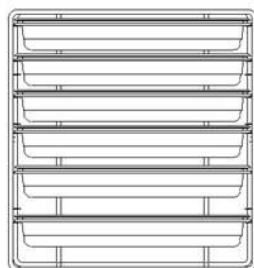
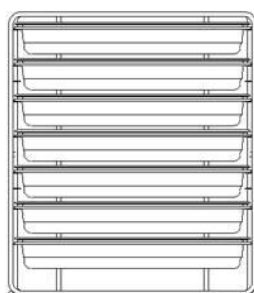

Capacity: 26 units

H100



Capacity: 20 units

H150

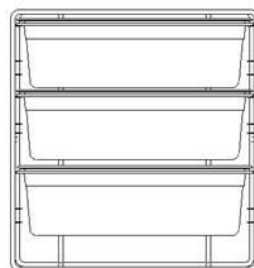
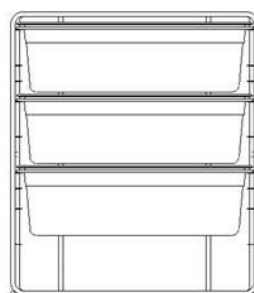

Capacity: 12 units

H200

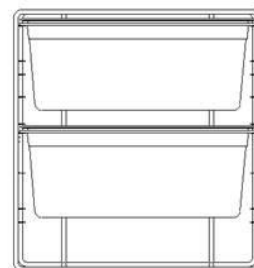
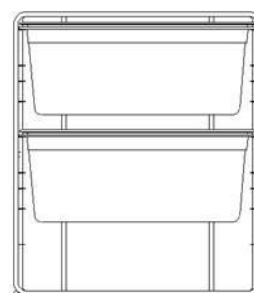

Capacity: 8 units

Model	Code	Colour	External dim. (mm)	Internal dim. (mm)	Capacity (liters)	Weight (Kg)
Cargo 500 Catering with castors and GN adaptors	05000086	Light blue	715X850Xh1675	540x660xh1370	500	108
Label holder	AMC101	transparent	173xh200	148xh210 -A5-		
9 guides lower GN adaptors stainless steel	AAA054	stainless	555x650xh585			9
9 guides upper GN adaptors stainless steel	AAA055	stainless	555x650xh685			9



Via Savigliano 34 - 12030 Monasterolo di Savigliano (CN)
 Tel. +39 0172812600 - Fax +39 017285991 - info@melform.com
www.melform.com