

# CARGO 500



**ATP**



## Isothermal container for the transport of chilled and frozen products at a controlled temperature

- Suitable for supermarket chains, logistics operators, chilled or frozen food distributors and manufacturers, carriers.
- 500 litres capacity.
- Total compliance with the cold chain at all stages of transport.
- Speeds up distribution operations at the point of sales: it can be loaded inside the cold room of the wholesale centre and unloaded at the refrigerated counter of the destination supermarket.
- It can be transported using conventional vehicles: it allows to simultaneously transport chilled, frozen and ambient temperature products using a single non-insulated vehicle.
- Manufactured using the rotational moulding technology: mono-block container and door (free of sharp edges, joints and welds).
- Fully recyclable at the end of the operating life.







### MANUFACTURING MATERIALS

<b>Polyethylene</b>	inner and outer walls of the container and the door; suitable for food contact	<b>Polyurethane</b>	insulating material between the walls of the container and the door; free of CFC and HCFC
<b>Silicone</b>	seal	<b>Nylon</b>	runners
<b>Galvanised steel</b>	support runners	<b>Stainless steel</b>	handling handles, closing handle, inner rod of the door, hinge rod

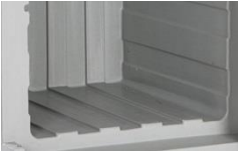
## TECHNICAL CHARACTERISTICS

	<p>4 runners of 100 mm diameter (2 fixed and 2 swivel of which one equipped with a brake). Support runners plate integrated in the container.</p>		<p>Pallets with galvanised steel frame 4 feet h 120 mm. Alternatively, the possibility of inclusion of 4 feet h 130mm in galvanised steel.</p>
	<p>1 seat for housing of the grid positioned at 600mm from the bottom of the container. Grid available on request.</p>		<p>Label holder (on request) for the identification of the content or destination. Suitable for A5 format documents.</p>
	<p>Available version specific to transport of fish with expansion plug to allow the drainage of the fish melted ice.</p>		<p>Available (on request) drip-tray to collect melt water of the ice used on the fish.</p>
	<p>Available (on request) adapters in stainless steel for GN pans.</p> <p>Transport capacity of 5 runners upper adapter (pitch 115mm): 10 GN1/1 h 65/100; 4 GN1/1 h 200/150.</p> <p>Transport capacity of 5 runners lower adapter (pitch 105mm): 10 GN1/1 h 65/100; 4 GN1/1 h 200/150.</p>		<p>Available (on request) towing set to move more than one container at the same time.</p>
	<p>Stainless steel locking handle with release button.</p>		<p>Handle prepared for the use of tamper-proof system.</p>
	<p>Chilled, frozen and extra frozen eutectic plates, to increase temperature retention performance over time (on request).</p>	<p style="font-size: 2em; text-align: center;"><b>CO<sub>2</sub></b></p>	<p>Prepared for the use of the cryogenic refrigeration system Cryo Power Box.</p>
	<p>Internal temperature can be checked through a thermometer installed in the door (on request).</p>		<p>Available (on request) USB data logger to record temperature data during transport.</p>

## TECHNICAL CHARACTERISTICS

	<p>Internal grooves improving good air circulation.</p>		<p>Door opens up to 270° with door retaining catch.</p>
	<p>Easily removable door seal.</p>		<p>Stainless steel rod with 2 hooks integrated inside the door.</p>
	<p>Mono-block structure, no sharp edges, joints and welds.</p>		<p>Insulated with CFC and HCFC-free polyurethane foam.</p>
<p><b>K</b></p>	<p>Overall heat transmission coefficient: <b>K = 0.35 W/m<sup>2</sup>K</b></p>	<p><b>°C</b></p>	<p>Guaranteed for use: <b>from -30° to +100° C.</b></p>

## TECHNICAL SPECIFICATIONS

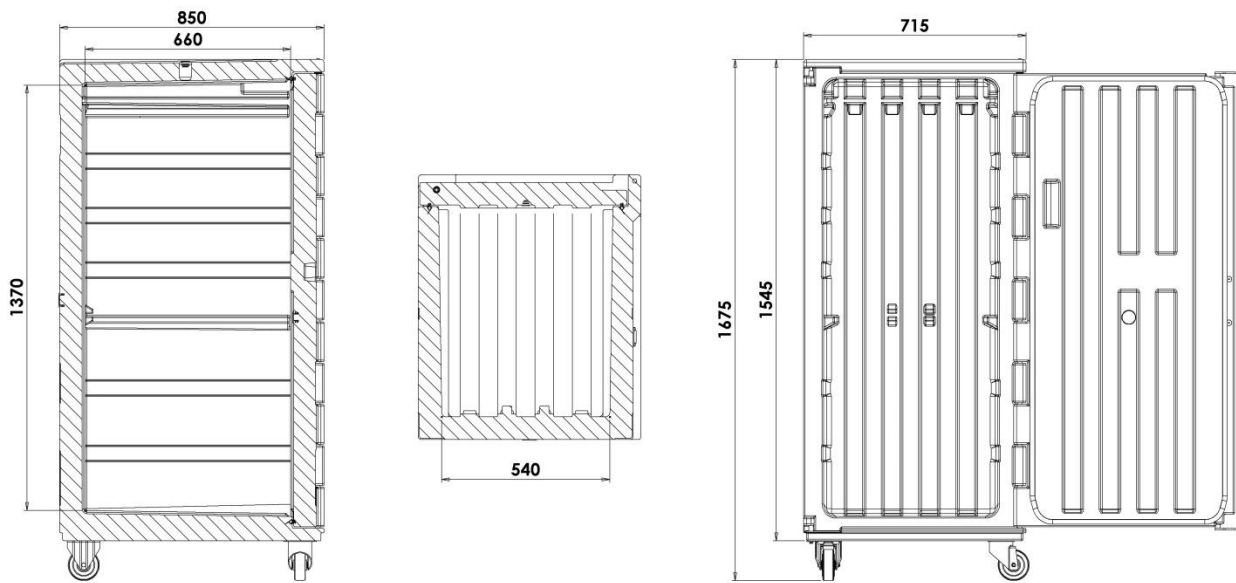

Model	Code	Colour	External dim. (mm)	Internal dim. (mm)	Capacity (liters)	Weight (Kg)
Cargo 500 with castors	05000071	melange grey blue	715X850Xh1675	540x660xh1370	500	90
Cargo 500 with feet	05000081	melange grey blue	715X850Xh1675	540x660xh1370	500	90
Cargo 500 with pallet	05000074	melange grey blue	715X850Xh1675	540x660xh1370	500	105
Label holder	AMC101	transparent	173xh200	148xh210 -A5-		
Grid in plastic	PAPE0001	grey	535x594xh20			1.8
Grid in stainless steel	AEA008	stainless steel	550x650xh16			
Drip tray	3516	white	655x538x127			4
Folding grid	PAPE0001	grey	535X594Xh20			1,1
5 guides lower GN adapter	AAA033	stainless steel	555x650xh585			9
5 guides upper GN adapter	AAA034	stainless steel	555x650xh685			9
Eutectic plate Chilled +3°C - 2 x Cargo -	PE500001	pink	540x325xh57			6.8
Eutectic plate Frozen - 21°C - 2 x Cargo -	PE500002	blue	540x325xh57			6.8
Eutectic plate Extra frozen - 21°C - 2 x Cargo -	PE500908	green	540x325xh57			6,8
Data logger USB	AFG007		80x33xh14			